

Example Sketch

### POLE BUILDING SKETCH

PLEASE INDICATE:  
 BAY/POST SPACING (ie: 10'/12'/Other): 10'  
 AND ANY STRUCTURAL DETAILS THAT  
 ARE UNIQUE WITH YOUR PROJECT

PLEASE MARK:  
 DESIRED POST LOCATIONS  
 DOOR & WINDOW LOCATIONS  
 DOOR SWINGS  
 OVERHANG LOCATIONS  
 CONCRETE FLOOR EXTENTS  
 BUILDING DIMENSIONS

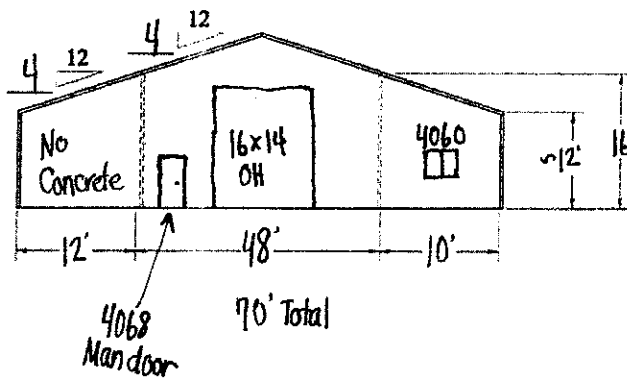
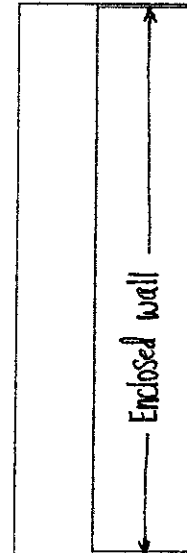
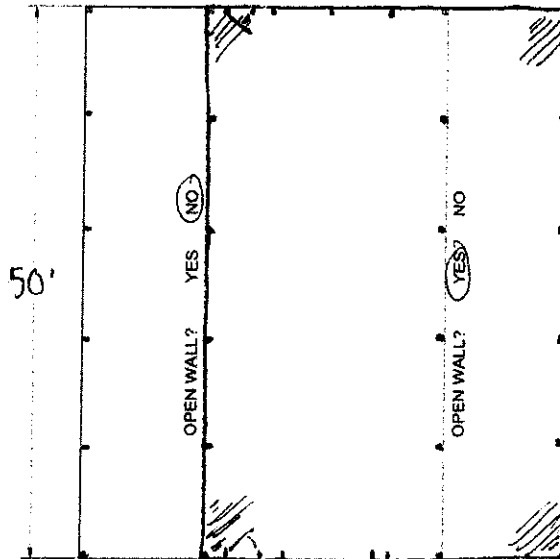
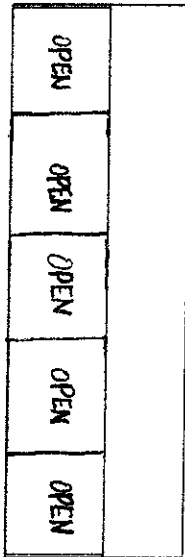
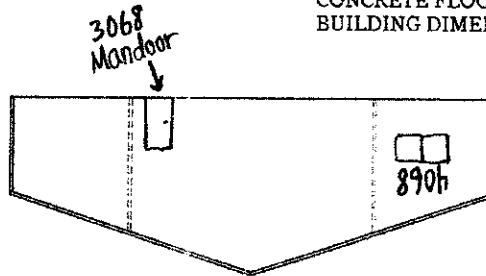

# POLE BUILDING SKETCH

PLEASE INDICATE:  
BAY/POST SPACING (ie; 10'/12'/Other): \_\_\_\_\_  
AND ANY STRUCTURAL DETAILS THAT  
ARE UNIQUE WITH YOUR PROJECT

PLEASE MARK:  
DESIRED POST LOCATIONS  
DOOR & WINDOW LOCATIONS  
DOOR SWINGS  
OVERHANG LOCATIONS  
CONCRETE FLOOR EXTENTS  
BUILDING DIMENSIONS

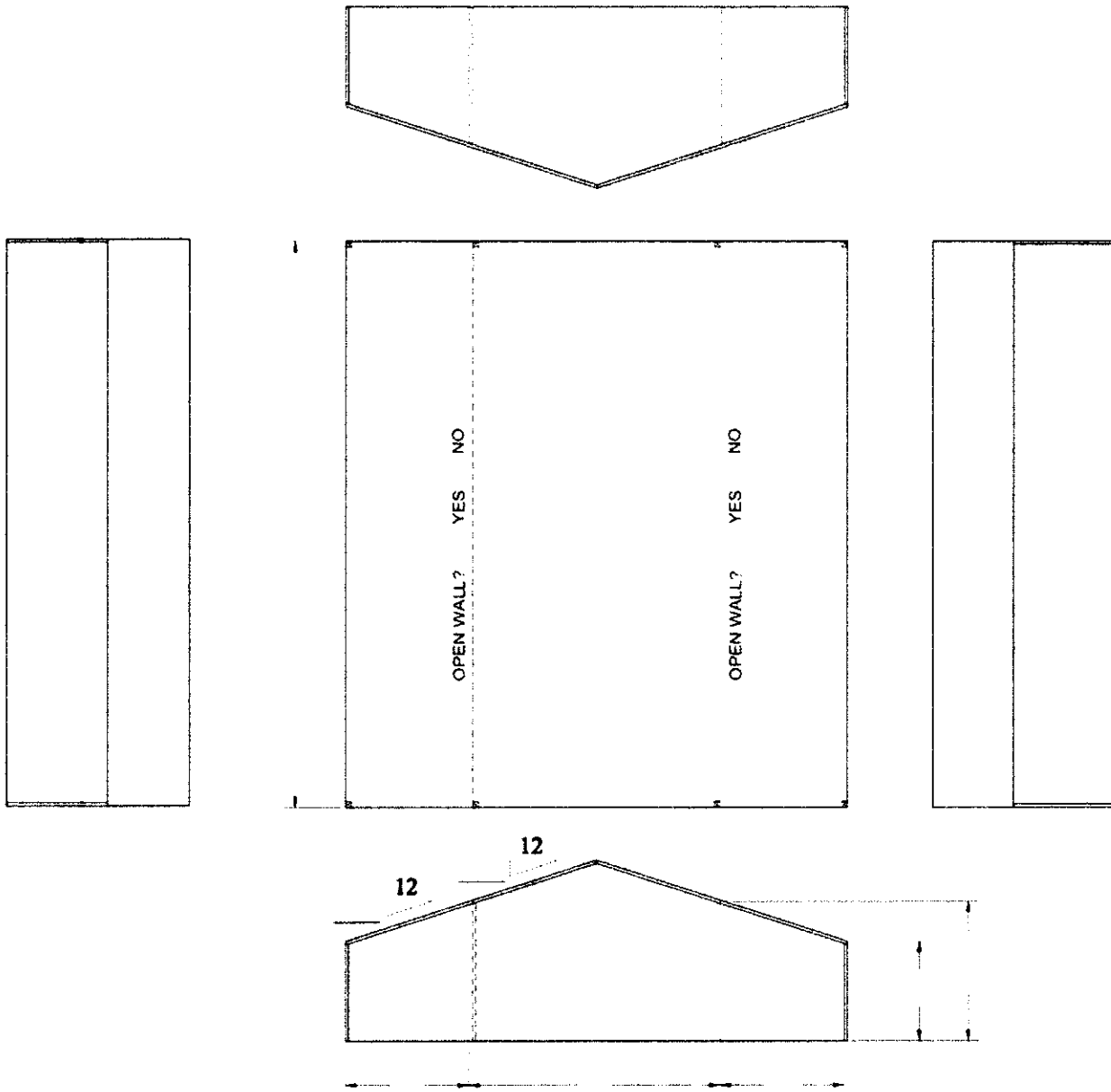

# POLE BUILDING SKETCH

**PLEASE INDICATE:**

**BAY/POST SPACING 10' / 12' / OTHER \_\_\_\_\_**

**PREFERRED POST LOCATIONS**

**DOOR AND WINDOW LOCATIONS**

**DOOR SWINGS**

**OVERHANG LOCATIONS**

**CONCRETE SLAB LIMITS**

**BUILDING DIMENSIONS**

**NORTH ARROW**

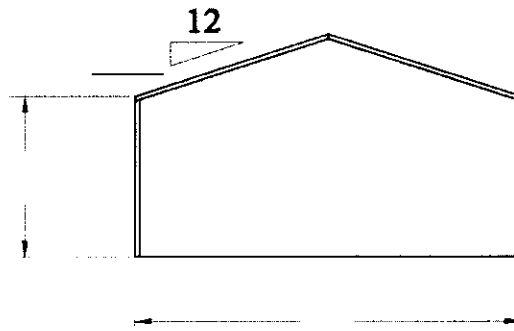
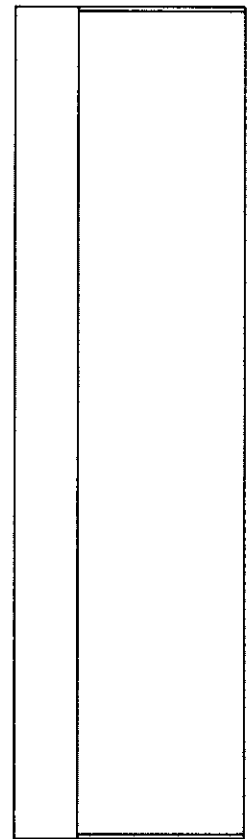
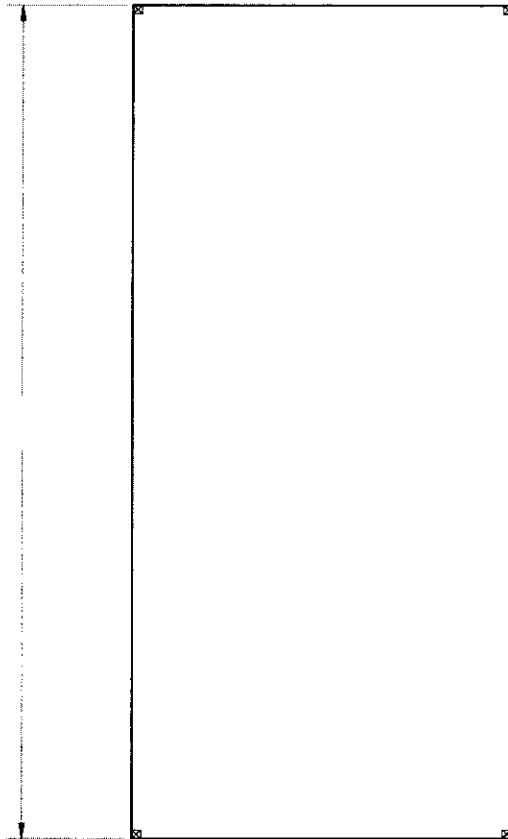
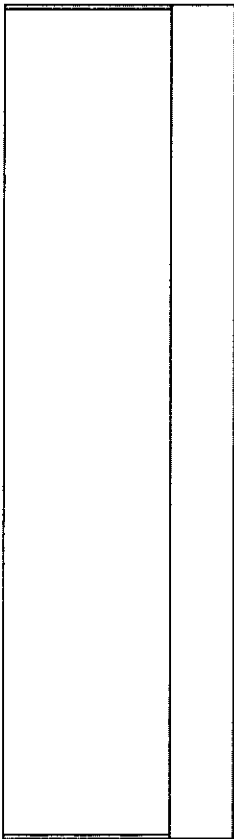
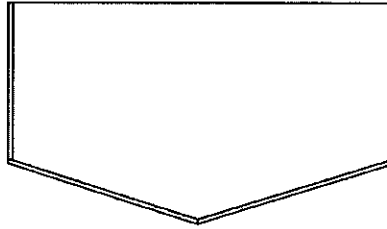

PLEASE INDICATE:  
BAY SPACING, 10' / 12' / OTHER \_\_\_\_\_  
PREFERRED POST LOCATIONS  
DOOR & WINDOW LOCATIONS  
DOOR SWINGS  
OVERHANG LOCATIONS  
CONCRETE SLAB LIMITS  
BUILDING DIMENSIONS

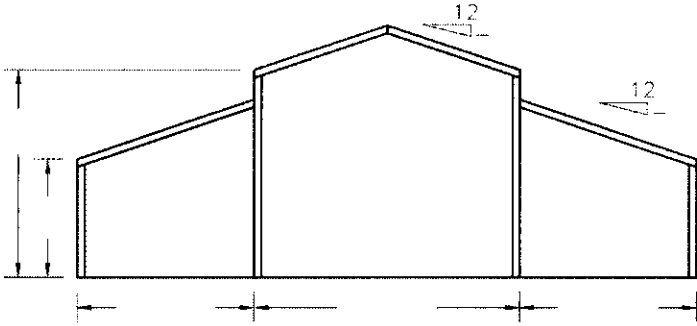
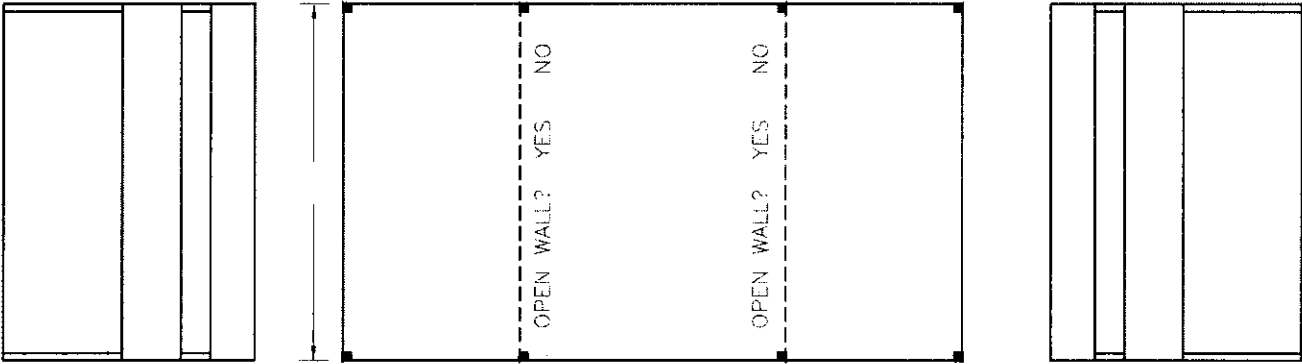
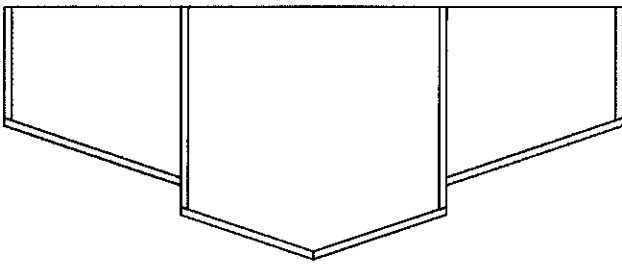

*POLE BUILDING SKETCH*

PLEASE INDICATE:  
BAY SPACING, 10' / 12' / OTHER \_\_\_\_\_  
PREFERRED POST LOCATIONS \_\_\_\_\_  
DOOR & WINDOW LOCATIONS \_\_\_\_\_  
DOOR SWINGS \_\_\_\_\_  
OVERHANG LOCATIONS \_\_\_\_\_  
CONCRETE SLAB LIMITS \_\_\_\_\_  
BUILDING DIMENSIONS \_\_\_\_\_

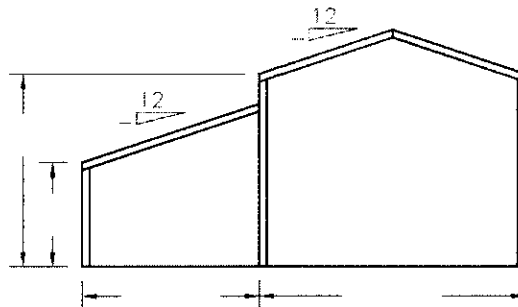
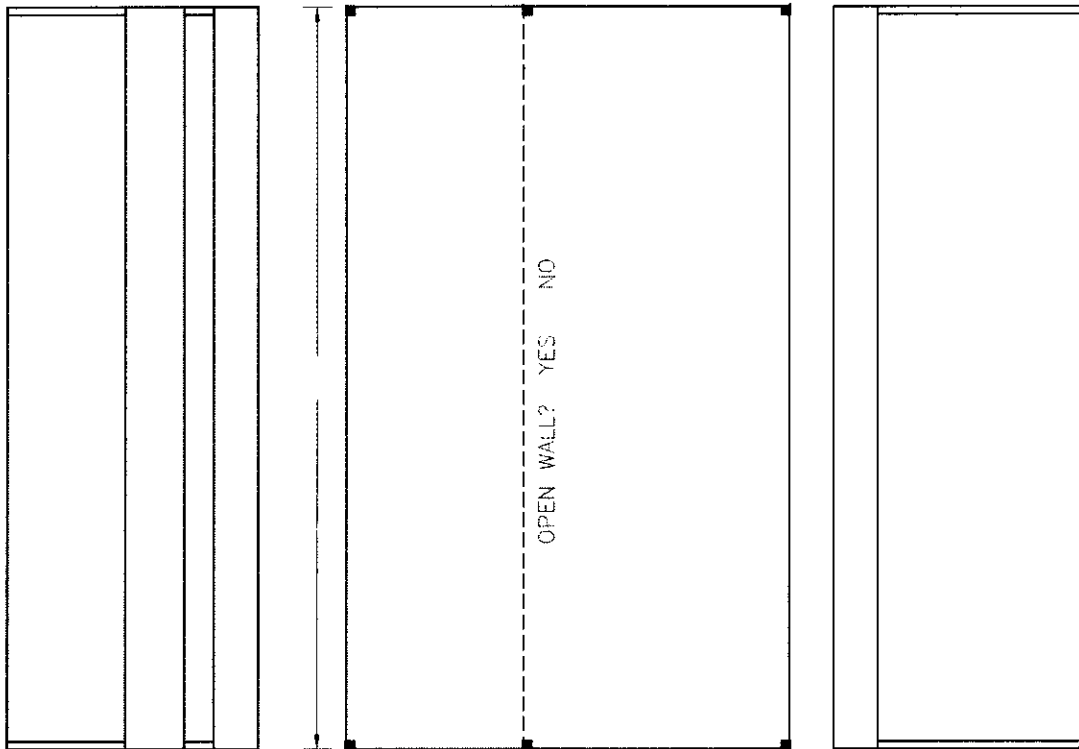
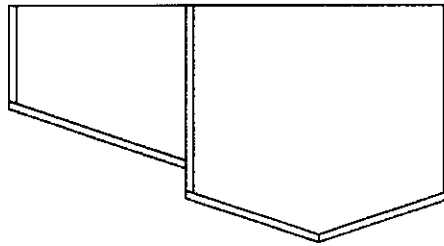

# POLE BUILDING SKETCH

**PLEASE INDICATE:**

BAY/POST SPACING 10' / 12' / OTHER \_\_\_\_\_

PREFERRED POST LOCATIONS

DOOR AND WINDOW LOCATIONS

DOOR SWINGS

OVERHANG LOCATIONS

CONCRETE SLAB LIMITS

BUILDING DIMENSIONS

NORTH ARROW

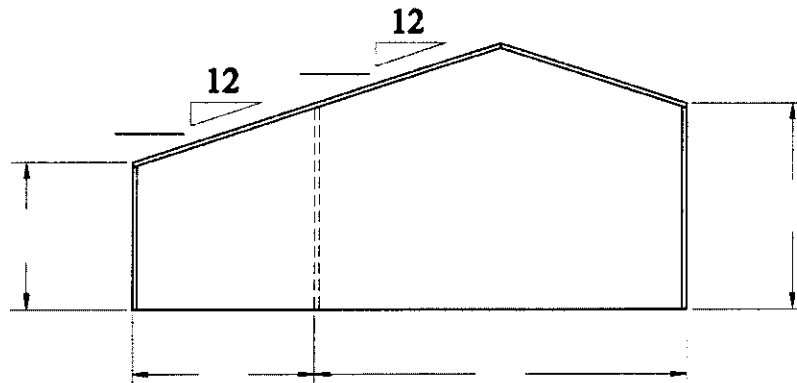
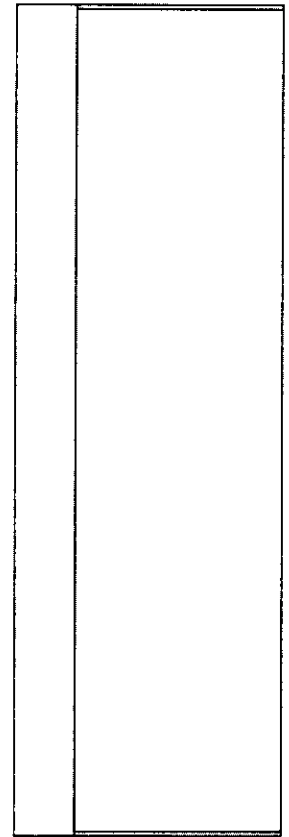
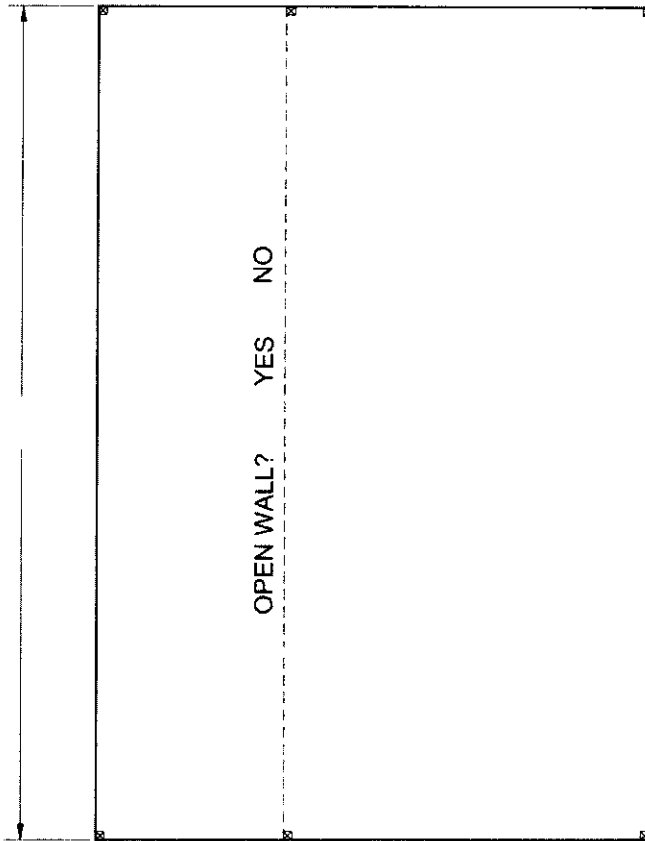
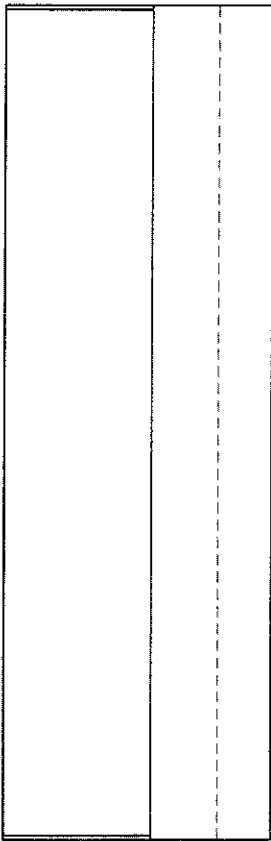
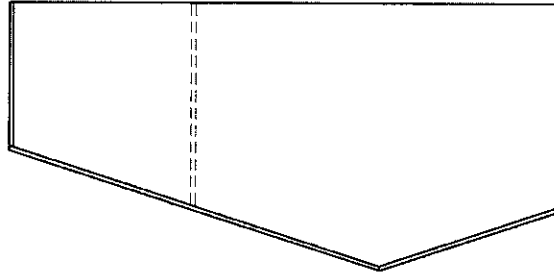

# POLE BUILDING SKETCH

**PLEASE INDICATE:**

BAY/POST SPACING 10' / 12' / OTHER \_\_\_\_\_

**PREFERRED POST LOCATIONS**

**DOOR AND WINDOW LOCATIONS**

**DOOR SWINGS**

**OVERHANG LOCATIONS**

**CONCRETE SLAB LIMITS**

**BUILDING DIMENSIONS**

**NORTH ARROW**

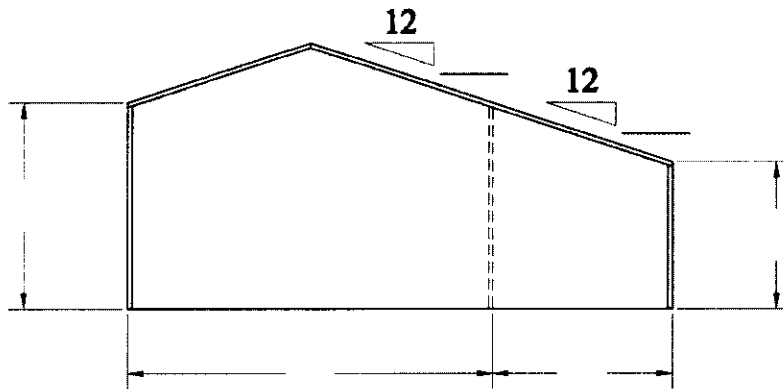
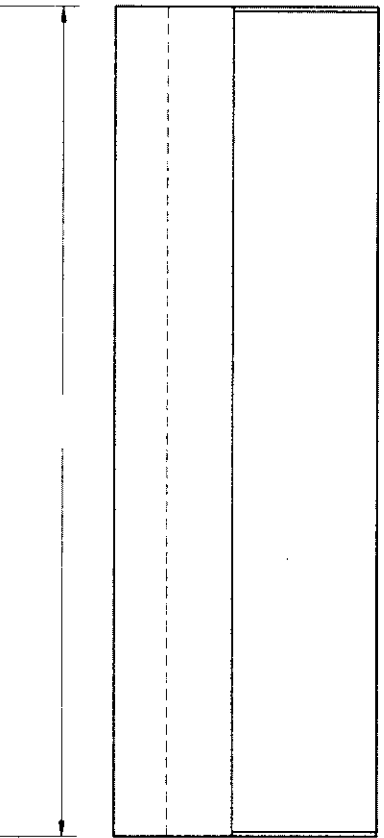
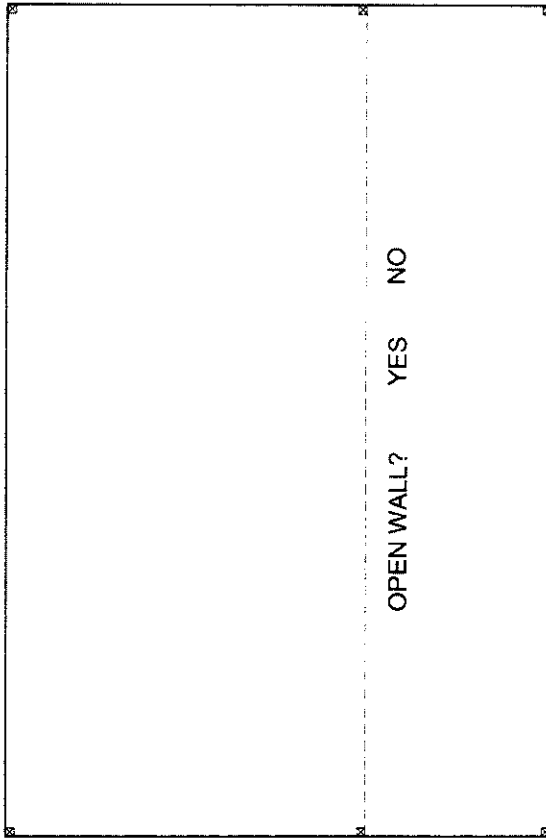
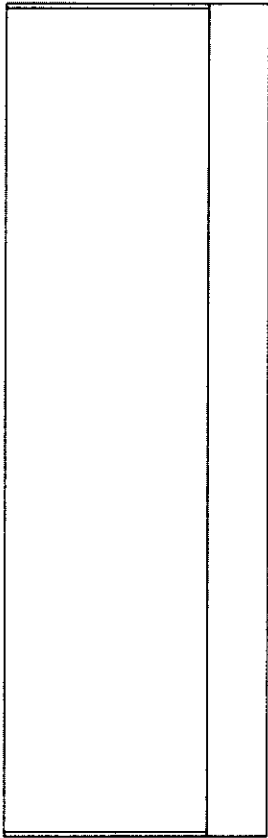
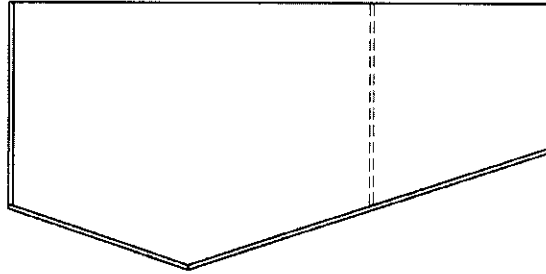

PLEASE INDICATE:  
BAY SPACING, 10' / 12' / OTHER \_\_\_\_\_  
PREFERRED POST LOCATIONS  
DOOR & WINDOW LOCATIONS  
DOOR SWINGS  
OVERHANG LOCATIONS  
CONCRETE SLAB LIMITS  
BUILDING DIMENSIONS

